

# EH1300TS-27.629M

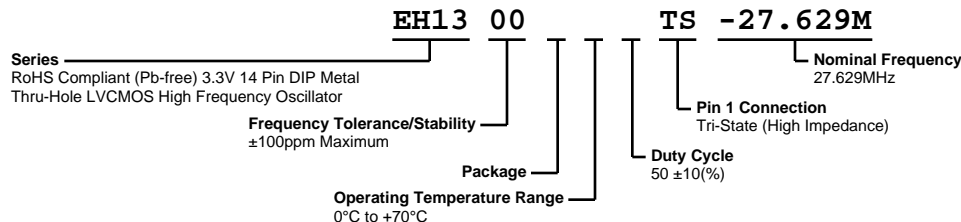

## ELECTRICAL SPECIFICATIONS

Nominal Frequency	27.629MHz
Frequency Tolerance/Stability	±100ppm Maximum (Inclusive of all conditions: Calibration Tolerance at 25°C, Frequency Stability over the Operating Temperature Range, Supply Voltage Chngem Output Load Change, Output Load Change, 1st Year Aging at 25°C, Shock, and Vibration)
Aging at 25°C	±5ppm/year Maximum
Operating Temperature Range	0°C to +70°C
Supply Voltage	3.3Vdc ±0.3Vdc
Input Current	35mA Maximum (No Load)
Output Voltage Logic High (Voh)	2.7Vdc Minimum (IOH = -8mA)
Output Voltage Logic Low (Vol)	0.5Vdc Maximum (IOL = +8mA)
Rise/Fall Time	6nSec Maximum (Measured at 20% to 80% of waveform)
Duty Cycle	50 ±10(%) (Measured at 50% of waveform)
Load Drive Capability	30pF Maximum
Output Logic Type	CMOS
Pin 1 Connection	Tri-State (High Impedance)
Tri-State Input Voltage (Vih and Vil)	70% of Vdd Minimum to Enable Output, 20% of Vdd Maximum to Disable Output, No Connect to Enable Output.
Absolute Clock Jitter	±250pSec Maximum, ±100pSec Typical
One Sigma Clock Period Jitter	±50pSec Maximum, ±40pSec Typical
Start Up Time	10mSec Maximum
Storage Temperature Range	-55°C to +125°C

## ENVIRONMENTAL & MECHANICAL SPECIFICATIONS

Fine Leak Test	MIL-STD-883, Method 1014, Condition A
Gross Leak Test	MIL-STD-883, Method 1014, Condition C
Lead Integrity	MIL-STD-883, Method 2004
Mechanical Shock	MIL-STD-202, Method 213, Condition C
Resistance to Soldering Heat	MIL-STD-202, Method 210
Resistance to Solvents	MIL-STD-202, Method 215
Solderability	MIL-STD-883, Method 2003
Temperature Cycling	MIL-STD-883, Method 1010
Vibration	MIL-STD-883, Method 2007, Condition A

# EH1300TS-27.629M

## MECHANICAL DIMENSIONS (all dimensions in millimeters)



PIN	CONNECTION
1	Tri-State (High Impedance)
7	Ground/Case Ground
8	Output
14	Supply Voltage

LINE	MARKING
1	<b>ECLIPTEK</b>
2	<b>EH13TS</b> EH13=Product Series
3	<b>27.629M</b>
4	<b>XXYZZ</b> XX=Ecliptek Manufacturing Code Y=Last Digit of the Year ZZ=Week of the Year

## OUTPUT WAVEFORM & TIMING DIAGRAM

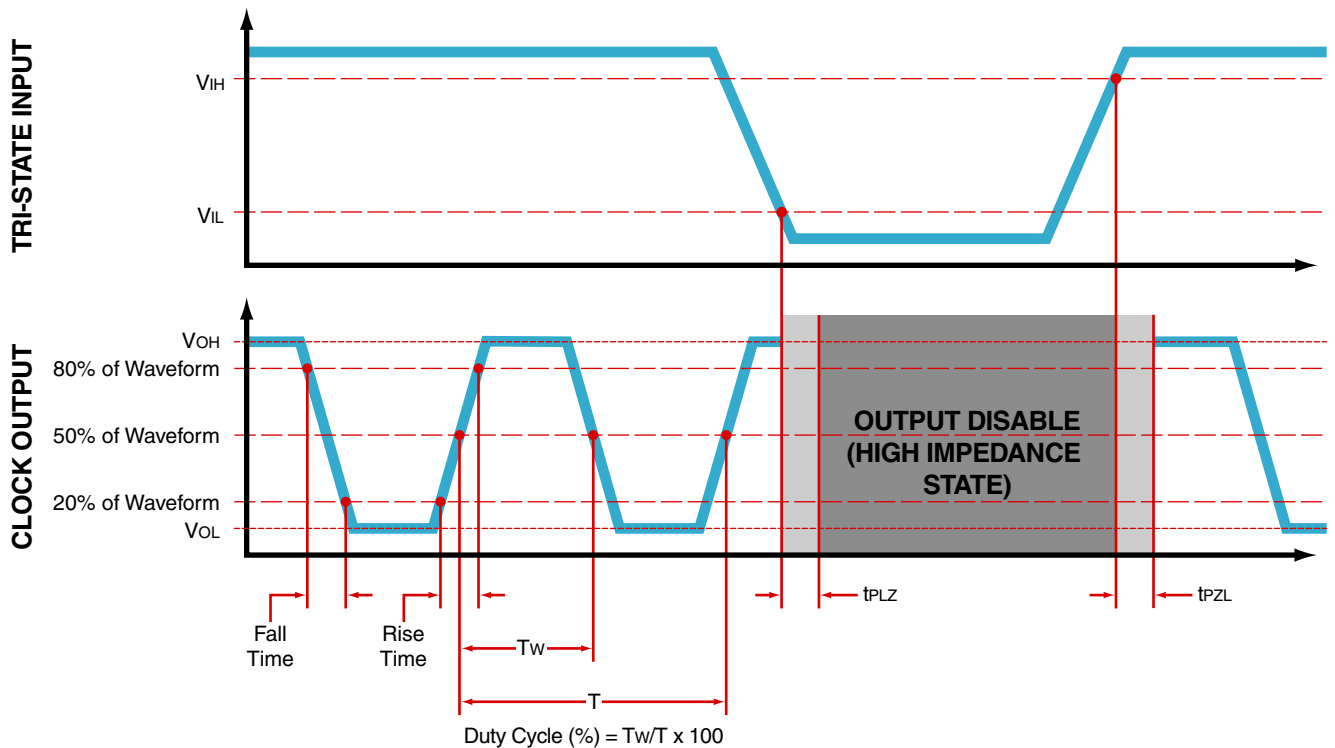

# EH1300TS-27.629M

## Test Circuit for CMOS Output

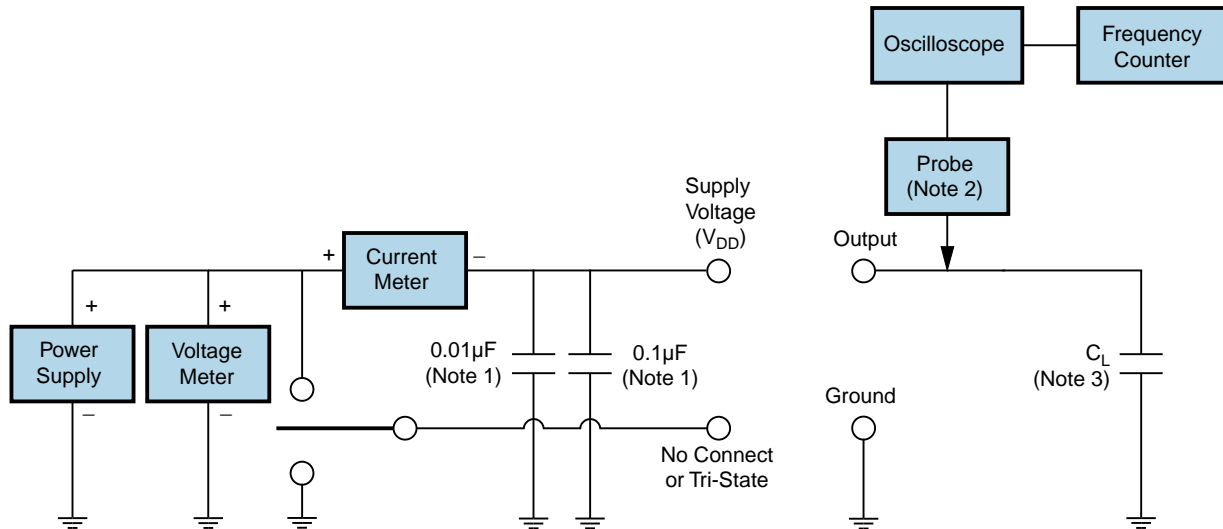

Note 1: An external  $0.1\mu\text{F}$  low frequency tantalum bypass capacitor in parallel with a  $0.01\mu\text{F}$  high frequency ceramic bypass capacitor close to the package ground and  $V_{DD}$  pin is required.

Note 2: A low capacitance ( $<12\text{pF}$ ), 10X attenuation factor, high impedance ( $>10\text{Mohms}$ ), and high bandwidth ( $>300\text{MHz}$ ) passive probe is recommended.

Note 3: Capacitance value  $C_L$  includes sum of all probe and fixture capacitance.

## Recommended Solder Reflow Methods



### High Temperature Solder Bath (Wave Solder)

<b><math>T_S</math> MAX to <math>T_L</math> (Ramp-up Rate)</b>	3°C/second Maximum
<b>Preheat</b>	
- Temperature Minimum ( $T_S$ MIN)	150°C
- Temperature Typical ( $T_S$ TYP)	175°C
- Temperature Maximum ( $T_S$ MAX)	200°C
- Time ( $t_s$ MIN)	60 - 180 Seconds
<b>Ramp-up Rate (<math>T_L</math> to <math>T_P</math>)</b>	3°C/second Maximum
<b>Time Maintained Above:</b>	
- Temperature ( $T_L$ )	217°C
- Time ( $t_L$ )	60 - 150 Seconds
<b>Peak Temperature (<math>T_P</math>)</b>	260°C Maximum for 10 Seconds Maximum
<b>Target Peak Temperature (<math>T_P</math> Target)</b>	250°C +0/-5°C
<b>Time within 5°C of actual peak (<math>t_p</math>)</b>	20 - 40 seconds
<b>Ramp-down Rate</b>	6°C/second Maximum
<b>Time 25°C to Peak Temperature (t)</b>	8 minutes Maximum
<b>Moisture Sensitivity Level</b>	Level 1
<b>Additional Notes</b>	Temperatures shown are applied to back of PCB board and device leads only. Do not use this method for product with the Gull Wing option.

## Recommended Solder Reflow Methods

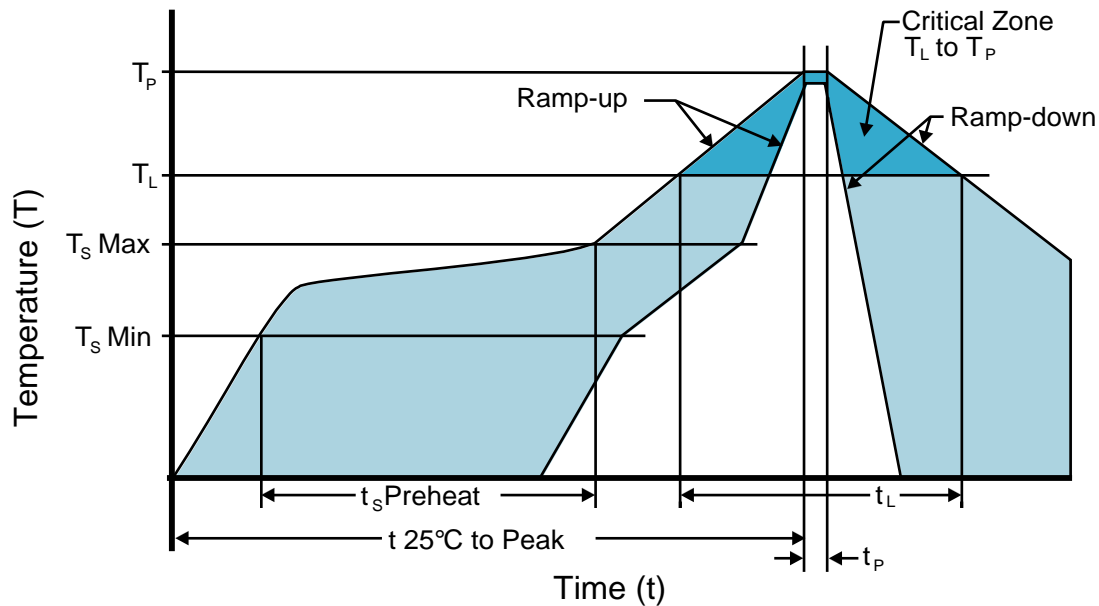

### Low Temperature Infrared/Convection 185°C

<b><math>T_s</math> MAX to <math>T_L</math> (Ramp-up Rate)</b>	5°C/second Maximum
<b>Preheat</b>	
- Temperature Minimum ( $T_s$ MIN)	N/A
- Temperature Typical ( $T_s$ TYP)	150°C
- Temperature Maximum ( $T_s$ MAX)	N/A
- Time ( $t_s$ MIN)	60 - 120 Seconds
<b>Ramp-up Rate (<math>T_L</math> to <math>T_p</math>)</b>	5°C/second Maximum
<b>Time Maintained Above:</b>	
- Temperature ( $T_L$ )	150°C
- Time ( $t_L$ )	200 Seconds Maximum
<b>Peak Temperature (<math>T_p</math>)</b>	185°C Maximum
<b>Target Peak Temperature (<math>T_p</math> Target)</b>	185°C Maximum 2 Times
<b>Time within 5°C of actual peak (<math>t_p</math>)</b>	10 seconds Maximum 2 Times
<b>Ramp-down Rate</b>	5°C/second Maximum
<b>Time 25°C to Peak Temperature (t)</b>	N/A
<b>Moisture Sensitivity Level</b>	Level 1
<b>Additional Notes</b>	Temperatures shown are applied to body of device. Use this method only for product with the Gull Wing option.

## Recommended Solder Reflow Methods



### Low Temperature Solder Bath (Wave Solder)

<b><math>T_s</math> MAX to <math>T_L</math> (Ramp-up Rate)</b>	5°C/second Maximum
<b>Preheat</b>	
- Temperature Minimum ( $T_s$ MIN)	N/A
- Temperature Typical ( $T_s$ TYP)	150°C
- Temperature Maximum ( $T_s$ MAX)	N/A
- Time ( $t_s$ MIN)	30 - 60 Seconds
<b>Ramp-up Rate (<math>T_L</math> to <math>T_p</math>)</b>	5°C/second Maximum
<b>Time Maintained Above:</b>	
- Temperature ( $T_L$ )	150°C
- Time ( $t_L$ )	200 Seconds Maximum
<b>Peak Temperature (<math>T_p</math>)</b>	245°C Maximum
<b>Target Peak Temperature (<math>T_p</math> Target)</b>	245°C Maximum 1 Time / 235°C Maximum 2 Times
<b>Time within 5°C of actual peak (<math>t_p</math>)</b>	5 seconds Maximum 1 Time / 15 seconds Maximum 2 Times
<b>Ramp-down Rate</b>	5°C/second Maximum
<b>Time 25°C to Peak Temperature (t)</b>	N/A
<b>Moisture Sensitivity Level</b>	Level 1
<b>Additional Notes</b>	Temperatures shown are applied to back of PCB board and device leads only. Do not use this method for product with the Gull Wing option.

### Low Temperature Manual Soldering

185°C Maximum for 10 seconds Maximum, 2 times Maximum. (Temperatures listed are applied to device leads only. This method can be utilized with both Gull Wing and Non-Gull Wing devices.)

### High Temperature Manual Soldering

260°C Maximum for 5 seconds Maximum, 2 times Maximum. (Temperatures listed are applied to device leads only. This method can be utilized with both Gull Wing and Non-Gull Wing devices.)